



**Safe Store, 198 - 202 Waterloo Road,
Birmingham, B25 8LD**

**0333 577 9597
info@vcomfort.co.uk
www.vcomfort.co.uk**

Primus 4D Pro

MASSAGE CHAIR

Model No: A550-2

OPERATION INSTRUCTIONS

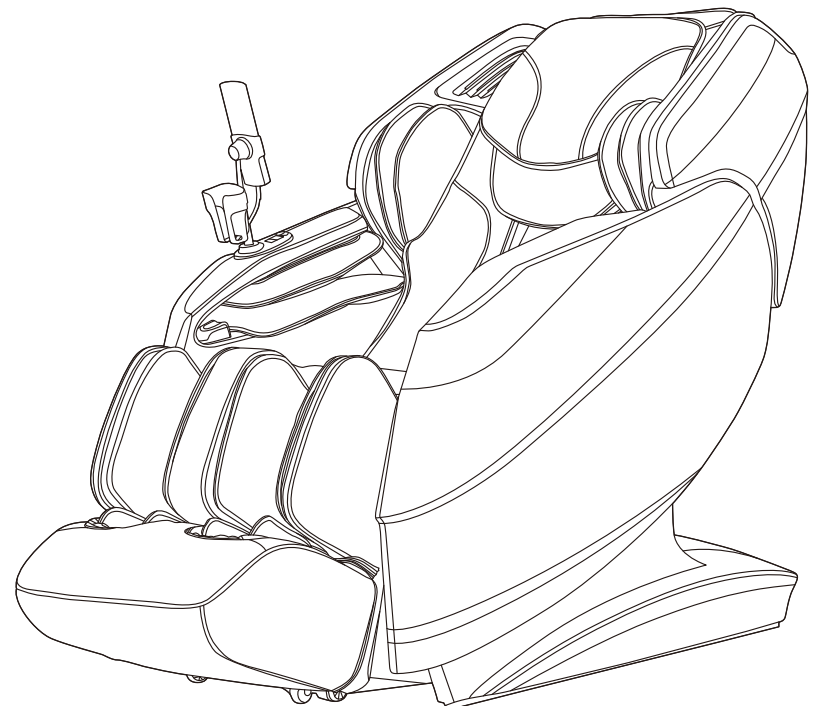

Thanks for purchasing this product. Please read this manual instruction carefully in order to know how to use this product correctly before operation. Please pay more attention to some important safety warning and keep this manual book properly for future use.

Note: Our company reserves the right to change and explain the design of the product. If there is some difference between the product function in market circulation and the description in the manual, it is a normal update of the product, and our company will not inform you otherwise. The specific product function and color shall prevail in kind.

CONTENTS

Before use

Safety precautions	02-04
Installation parts	05
Place massage chair	06-07
Before use	08-09
Product structure	10-16

Usage method

Operation Instructions	17-31
Massage close	31-32

Maintain



Cleaning and Maintenance	33
--------------------------	----

Important

Troubleshooting	34
Product Specifications	35

Safety Precautions must be observed

- Please read all relevant instructions carefully before use.
- The notes marked here will help you to use the product safely and correctly.
- In order to clearly indicate the extent of harm and damage, precautions are divided into **"Warning"** and **"Caution"** that may be caused by incorrect use. Both of them are important for safety and must be followed.

 Warning	Indicates that serious injury or death may result from improper use.
 Caution	Indicates that misuse may cause minor injury or property damage.

- Please pay attention to the symbol before each safety item.

 Forbidden	Absolute prohibition
--	----------------------

The following populations should not use this product

 Forbidden	<ul style="list-style-type: none"> ■ The device is not intended for use by persons (including children) with physical disabilities, sensory or neurological impairments or who lack experience and common sense, unless they are supervised and instructed in the use of the device by those responsible for their safety. Children must be supervised to ensure they do not play with instruments. ■ Patients with osteoporosis. ■ Patients with heart disease or wearing electronic medical devices such as a pacemaker. ■ People who have a fever. ■ Pregnant women or women on their menstrual period. ■ Patients who are injured or have a skin disease. ■ When unsupervised, any children are under the age of 14 and those unconscious are not allowed to use this product. ■ People who are told by their physicians to have rest or who feel unwell. ■ People whose bodies are wet are forbidden to use this product. ■ This product has a hot surface. Persons insensitive to heat must pay attention when using this product. ■ If the supply cord is damaged, to avoid danger, it must be replaced by a professional from the manufacturer, its maintenance department or similar department
---	---



Safety Precautions must be observed

Important safety warnings	
 Warnings	<ul style="list-style-type: none"> ■ Do not allow children to touch any movable part of this product. ■ Use the well-grounded power supply unit suitable for this product. ■ Pull out the plug after use or before cleaning to avoid any physical injury or damage to the product. ■ Operate this product as instructed in this manual. ■ Do not use any parts or accessories which are not recommended. ■ Do not use this product outdoors. ■ Please read the Operation Instructions carefully before operation. ■ Never use this product for any other purpose not listed herein. ■ 20 minutes of usage each time is recommended. ■ Do not use this product if the cover or leather is broken or damaged. ■ Do not drop anything into this product. ■ Never fall asleep while using this product. ■ Do not use this product if you are drunk or feel unwell. ■ Do not use this product within one hour after a meal. ■ Do not use this product with excessive force to avoid any injury.

Safety precautions	
 Caution	<ul style="list-style-type: none"> ■ Check whether voltage is consistent with the specification of this product. ■ Never insert or pull out the plug with a wet hand. ■ Do not let water flow into this product to avoid electric shock or cause damage to this product. ■ Do not pull the power cord when plugging or unplugging it. Rough handling is forbidden. ■ Do not damage the wire or modify the circuit of this product. ■ Do not clean live parts of this product with a wet cloth such as a power switch and plug. ■ Be away from this product in case of power failure to avoid any injury if power is restored suddenly. ■ Stop using this product at once while it works abnormal, and consult your local supplier. ■ Stop using this product if you feel unwell, and consult your health care practitioner.

Storage conditions	
 Caution	<ul style="list-style-type: none"> ■ Storage room temperature: 5 °C to 40 °C. ■ Relative humidity (RH) between 20% and 80%; free of corrosive gases, and a well-ventilated room.

Safety Precautions must be observed

Product service and maintenance	
 Caution	<ul style="list-style-type: none">■ This product should be maintained by the service center designated by the manufacturer only. No user should disassemble or maintain it without permission.■ Do not forget to turn off the main power switch after usage.■ Do not use this product if the power socket becomes loose.■ If this product will be left unused for a long period of time, it is necessary to roll up the power cord of this product and store this product in a dry and dust-free environment.■ Do not store this product at a high temperature or near open flame. Avoid prolonged exposure to direct sunshine.■ Please clean this product with dry cloth. Never use thinner, benzene or alcohol.■ The mechanical components of this product are specially designed and manufactured, so no special maintenance is needed.■ Do not use a sharp object to stab at this product.■ Do not roll or pull this product on any uneven ground. Instead, it should be lifted before moving.■ Please use this product intermittently. Do not keep it working continuously for a long period of time.
Operating environment	
 Caution	<ul style="list-style-type: none">■ Do not use this product in a very moist environment such as the bathroom.■ Stop using this product immediately when the ambient temperature changes sharply.■ Do not use this product in any heavily-dusty or caustic environment.■ Do not use this product in a small space or a place without good ventilation.
Solutions to ordinary malfunctions	
 Caution	<ul style="list-style-type: none">■ If the motor sounds during operation of this product, this is the normal operation sound.■ If the controller cannot work normally, check whether the plug and the power socket are connected reliably, and whether the power switch is turned on.■ If the rated working time is over, this product will automatically activate the power-off button; If this product keeps operating for a long period of time, the temperature protector will stop this product automatically. The product can be used again after half an hour.

Installation parts

Calf mechanism installation instructions

1. Insert the cable and air pipe of the calf mechanism, respectively, into the sockets at the front of the steel frame assembly (Figure 1).
2. After the connection is completed, open the calf mechanism fixing covers on both sides of the steel frame assembly (Figure 2).
3. Raise the calf mechanism and put it into the slot and cover the fixing cover and finally fix it in place with 2 M4 screws (Figure 3).

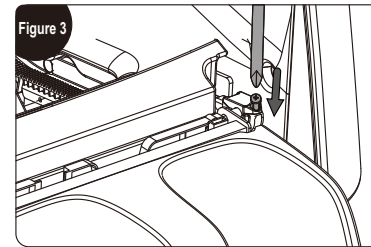
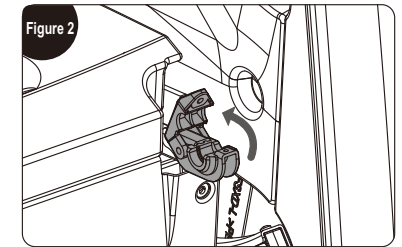
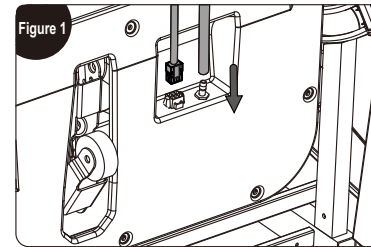

Place massage chair

Installation placement

Make sure there is enough space for the massage chair can be tilted at least 12 cm.



Do not expose the massage chair directly to high temperature environment due to sunlight (such as: in front of heating equipment), and place it to where can avoid high temperature and direct sunlight. It is recommended to lay a soft cushion for long-term use in a designated location. When laying the cushion, the size of the cushion should be enough to cover the range where the machine touches the floor and the range where your feet touch the floor.

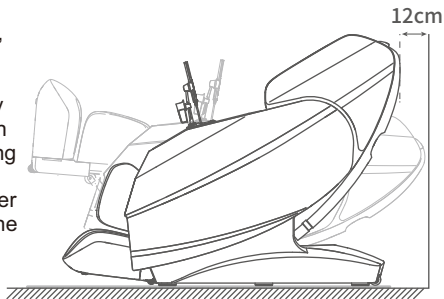

Product lift instruction

Require team work to lift and move the chair to avoid injury.



1. Please lift the massage chair to move it on vulnerable ground such as wooden floor.
2. When moving on a similar wooden floor, it is recommended to lift it. Avoid damage to the casters. When the floor is lifted and moved to the designated position, be careful to keep your hands out of the way to avoid injury, and be careful of your feet being crushed. Do not let go of the unit until the unit is completely flat, the floor may be damaged, therefore, it is recommended to place mats, etc. on the floor.

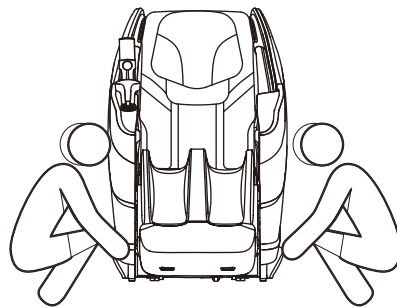

Place massage chair

Move method

Use the rear casters to move the massage chair. Move the chair by tilting it down and backward about 45° as shown in the diagram.



NOTE: Excessive force to tilt will cause the chair to tip over completely and product damage.

1. Before moving, please shut down the machine properly to reset the whole machine, and then cut off the power.
2. Please keep the chair vacant when moving. (People, pets or clutter will not be able to stay on the chair.)
3. When moving, do not cross a drop barrier higher than 2mm or a gap greater than 5mm.
4. When using casters to move this product, single continuous movement is not supported; if the distance exceeds 50 meters, please make this product move slowly and evenly.

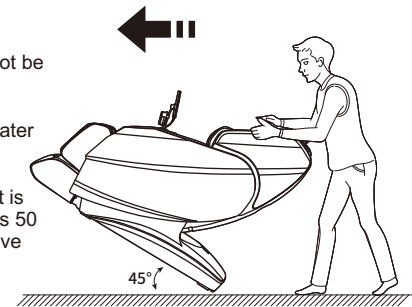

How to disassemble and use headrest cushion and backrest cushion

Using a headrest cushion can reduce the intensity of kneading massage on the neck and shoulders, and you can decide whether to use a headrest cushion according to your needs (recommended to use a headrest cushion). The backrest cushion and the backrest are connected by a zipper (1), and the headrest cushion and the backrest cushion are connected by a zipper (2).

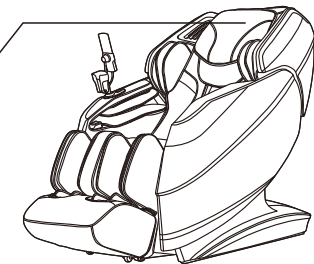
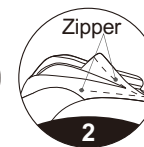
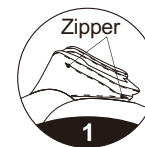

Before use

Check around

Make sure that there are no people, pets and other objects around the unit.

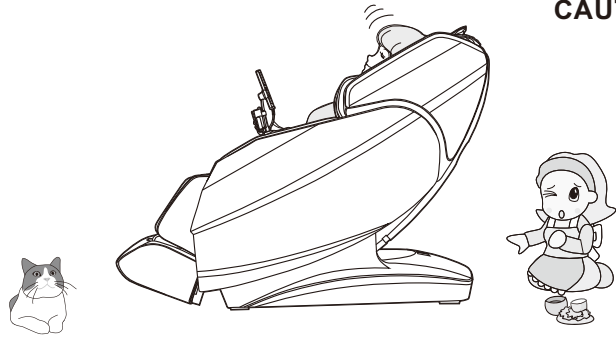

Make sure there are no foreign objects in the gaps of the machine

Before massaging, make sure that no foreign objects are caught in the legs, feet, etc.

Under no circumstances allow hands, feet, and head to penetrate into the area between the lower leg mechanism and main body, or the area between the armrest and the capsule.

Under no circumstances should hands, feet, or head sink under the fabric or leather covering of the massage area.

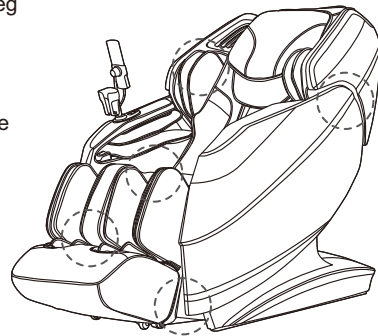

Before use

Turn on the power

CAUTION

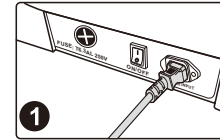

1 Plug in power cord

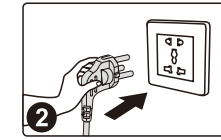

2 Schematic diagram of power on

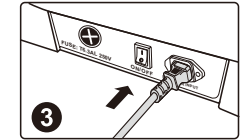

3 Turn on the power switch ("I" position)



- Please check the power cord and plug for damage before use.
- Please supply power to this product in accordance with the working power requirements of this product's calibration.
- It is strictly forbidden to use a power supply other than the nominal power supply of this product.
- It is strictly forbidden to connect various power conversion devices without authorization to supply power to this product.

Product structure

Description of components

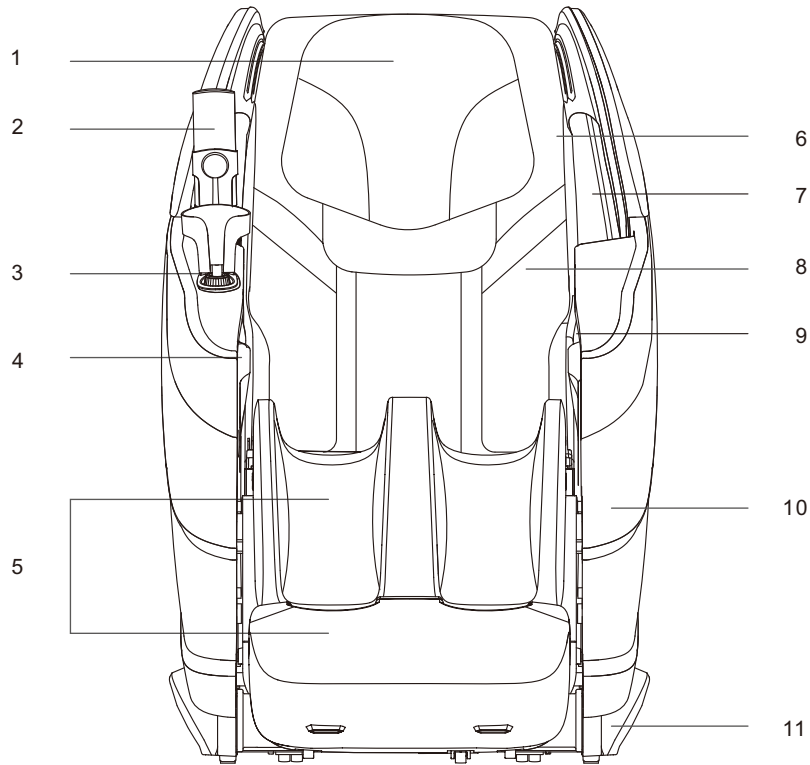

- 1.Head cushion
- 2.Remote control
- 3.Armrest shortcut keys
- 4.Health sensor
- 5.Leg massage unit
- 6.Back cushion

- 7.Shoulder air pressure
- 8.Shoulder mechanism
- 9.Arm air pressure
- 10.Armrest
- 11.Side cover

Product structure

Schematic view of functional distribution

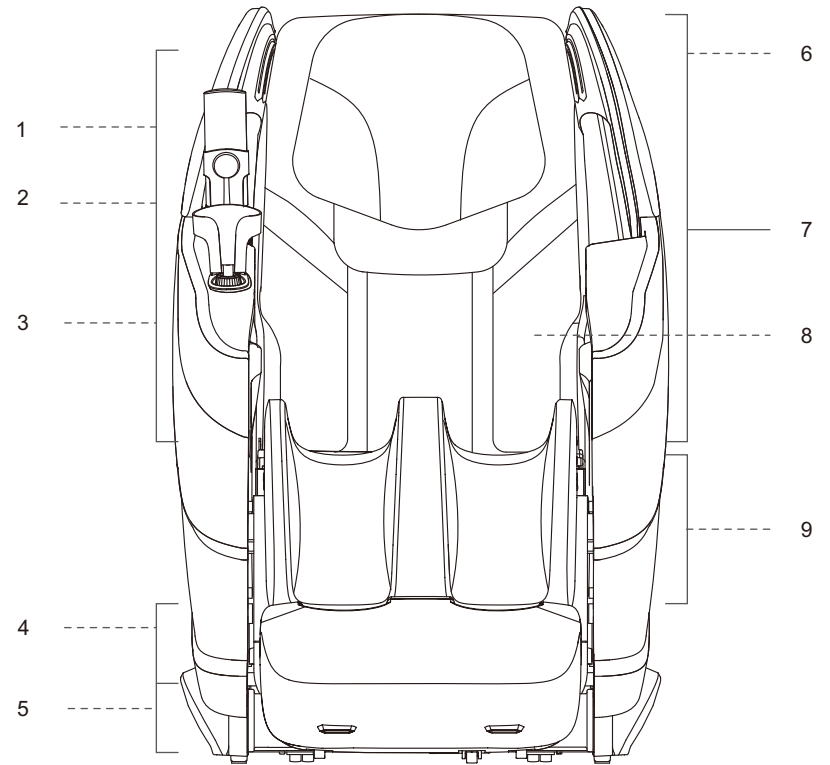

- 1.Shoulder:
Air sac massage
- 2.Arm:
Remote control holder
Mobile phone holder
USB charging port
- 3.Hand:
Air sac massage
- 4.Leg:
Air sac massage

- 5.Sole:
Roller massage
- 6.Both sides of the head:
3D digital audio Play music
- 7.Head and neck to bottom:
Mechanical massage
- 8.Waist and shoulder heating:
Heating function
- 9.Leg:
Air sac massage

Product structure

How to use the shawl

- It is provided with a unique shawl assembly, with innovative heating functions on the shoulder, back, waist and abdomen and heating with graphene. Users can place the shawl at different massage positions according to massage requirements. When the shawl assembly is placed at the shoulder position, it will heat the acupoints such as Bingfeng, Tianzong, Yunmen and Qihu around the shoulder and clavicle by graphene heating, effectively relieving symptoms such as scapulohumeral periarthritis and cough, and removing cold and moisture from shoulder joints.
- When the shawl assembly is placed on the abdomen and back (dual-purpose), through graphene heating, it plays the role of dispelling cold and relieving pain, warming channels and removing blood stasis in the back and abdomen, distributing Qi and blood of the back and abdomen meridian, alleviating the symptoms such as irregular menstruation and dysmenorrhea for women, relieving low back pain and kidney discomfort, warming intestines and stomach and clearing intestinal cold, with a good effect on some people with deficiency of qi and deficiency of spleen and stomach.

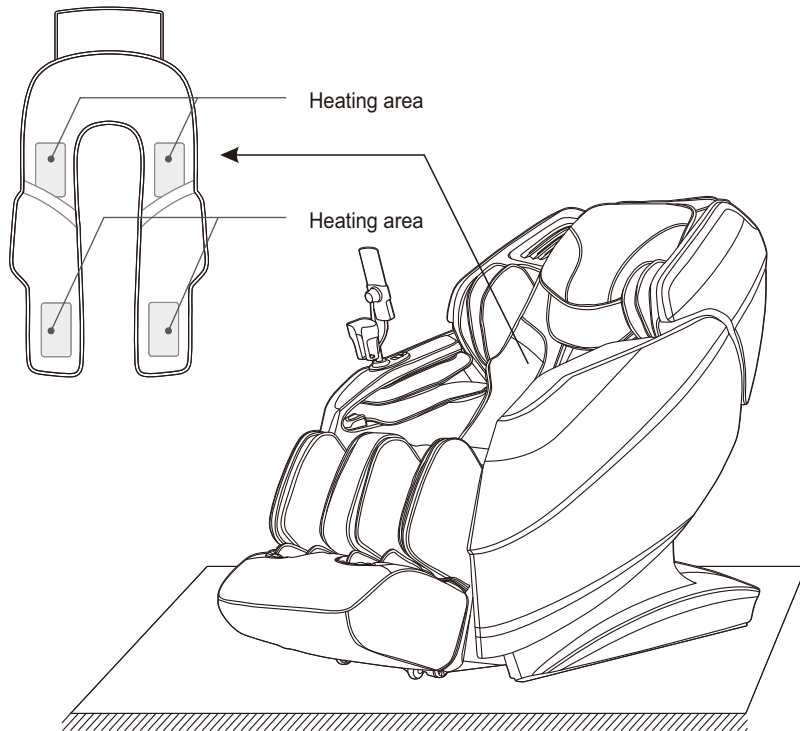

Product structure

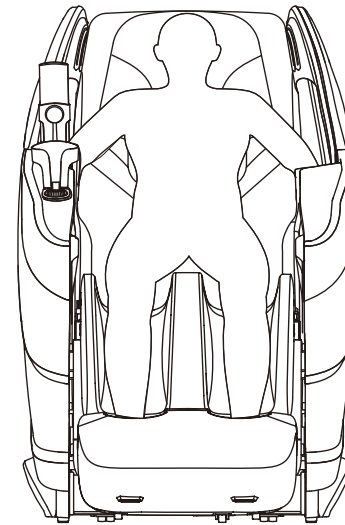

Schematic diagram
of use on back and waist

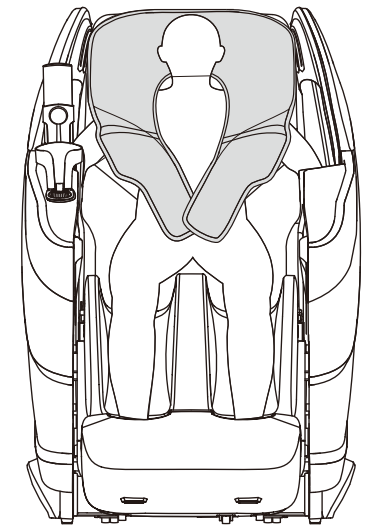

Schematic diagram
of use on shoulder and abdomen

Product structure

I. Remote control key description

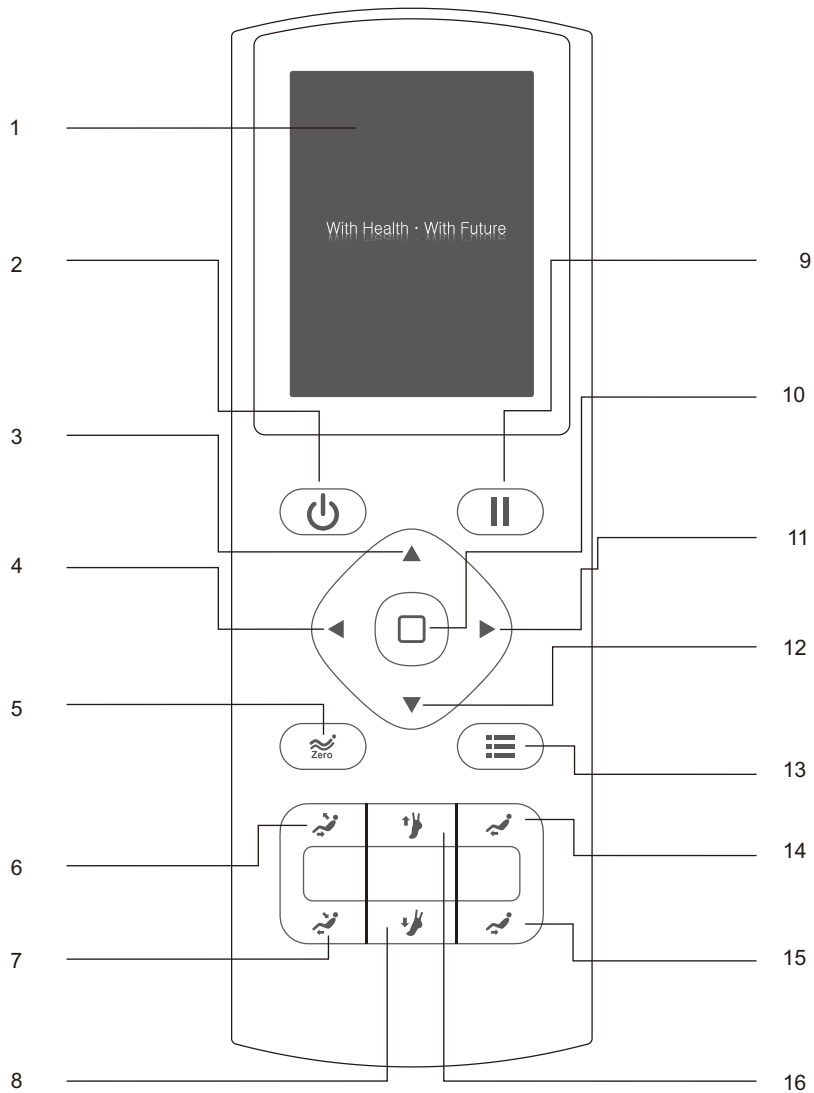

Product structure

1. Display
2. On/off key
 - Turn the massage chair on or off.
3. Up key
 - The key for upward navigation. You can press this key to scroll up to select a menu item or make an increase adjustment.
4. Left key
 - The key for leftward navigation. You can press this key to scroll leftwards to select an item or return to the previous menu.
5. Zero-gravity key
 - Sets the zero-gravity angle to "zero-gravity I," "zero-gravity II," "zero-gravity III" or "off."
6. Sitting position raising key
 - Upturns the massage chair.
7. Sitting position lowering key
 - Turns down the massage chair.
8. Leg mechanism extending key
 - Extends the leg mechanism.
9. Pause key
 - Pause the massage or exit from pause massage
10. OK key
 - Confirms or cancels the selection of a massage function.
11. Right key
 - The key for rightward navigation. You can press this key to scroll rightwards to select an item or return to the next menu.
12. Down key
 - The key for downward navigation. You can press this key to scroll down to select a menu item or make a decrease adjustment.
13. Menu key
 - Enter the main menu interface.
14. Leg mechanism raising key
 - Raises the leg mechanism.
15. Leg mechanism lowering key
 - Lowers the leg mechanism.
16. Leg unit shrinkage key
 - Leg unit shortening.

Product structure

II. Armrest shortcut key description

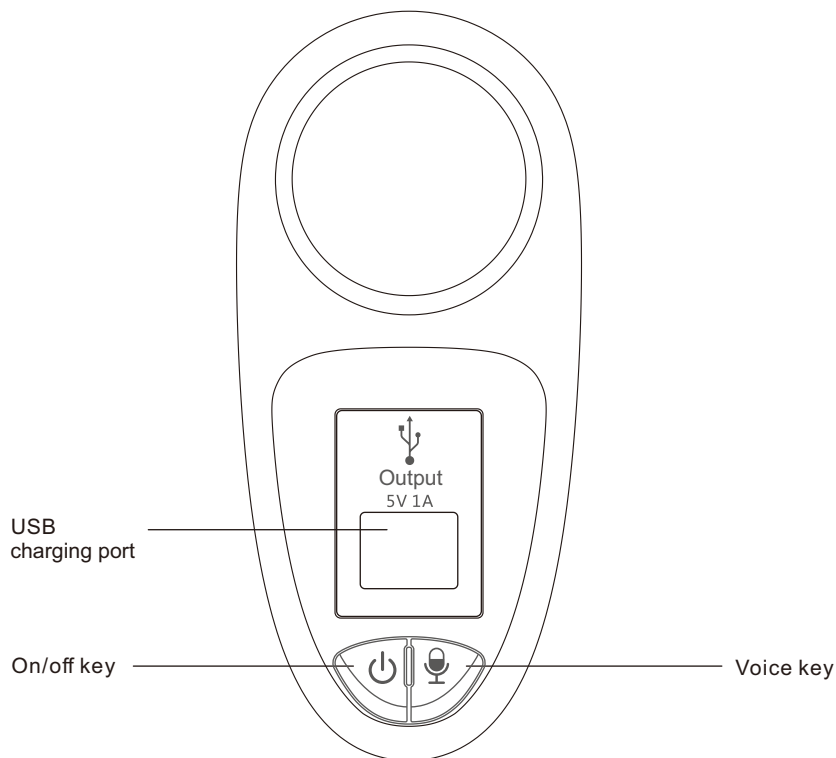

USB charging port Charges mobile phones or other electronic devices.

On/off key A long press of this key can turn the massage chair on or off and a short press pause or exit the massage.

Voice key A long press of this key can enable or disable the voice assistant function and a short press can wake up the voice assistant.

Operation Instructions

III. Start massage

1. Press the On/Off key on the remote control or press and hold the On/Off key on the right armrest to turn on the chair.
2. Wait to select the automatic program. Select the automatic program according to the remote control or voice prompt. If there is no operation for more than 20 minutes, it will be turned off automatically.
3. Automatic angle adjustment: After the automatic program is selected, the massage chair will automatically adjust to the zero-gravity angle. You can wait until the adjustment is completed, or press the OK key to skip to the next step.

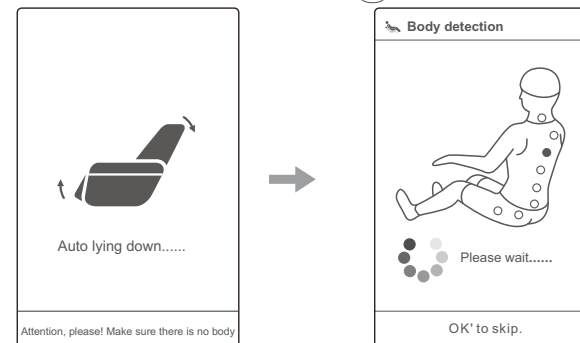



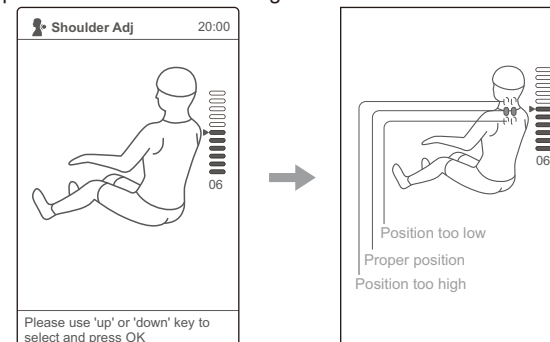

Automatic angle adjustment diagram Body shape detection diagram

4. You can wait until the body shape detection is completed or press the OK key to skip the detection and start the massage directly.
5. Shoulder position fine adjustment: After the body shape detection is completed, the remote control or the voice prompt will prompt the user to finely adjust the shoulder positions. If the massage rollers just stop on your shoulders, this adjustment is not needed and you can skip it and directly press the OK key to start the massage. Otherwise, please adjust the massage rollers to your shoulders with the Up key and the Down key and press the OK key to start massage. If no operation is made within 20s, directly default the current massage roller position for the shoulder position and start the massage.



Operation Instructions

IV. Pause function (please use this function after the chair is turned on)

After the massage chair is turned on, you can press the Pause key  or the On/Off key  on the armrest to enter the pause state and then all massage functions will stop. You can press the Pause key  again or press the On/Off key on the armrest  to resume the massage.

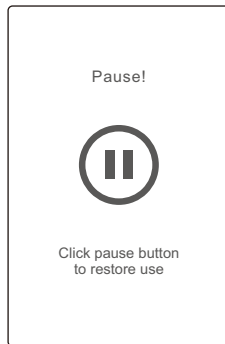

Note: In the pause state, no other functions but the power-down function can be used.



Message pause state diagram

V. Automatic program (please use this function after the chair is turned on)

1. Automatic program selection

- (1) Press the Menu key  on the remote control to open the main menu.
- (2) Select the automatic program option and press OK key  to open the automatic program menu.

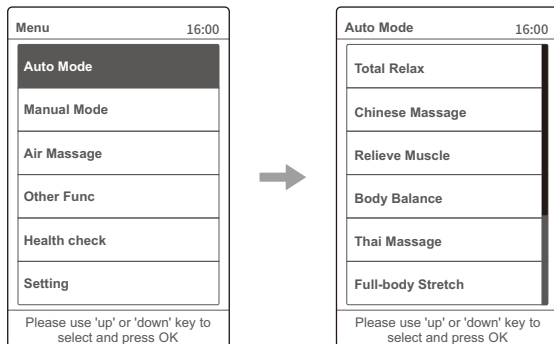

Operation Instructions

- (3) Select the desired automatic program and press the OK key  to start massage.

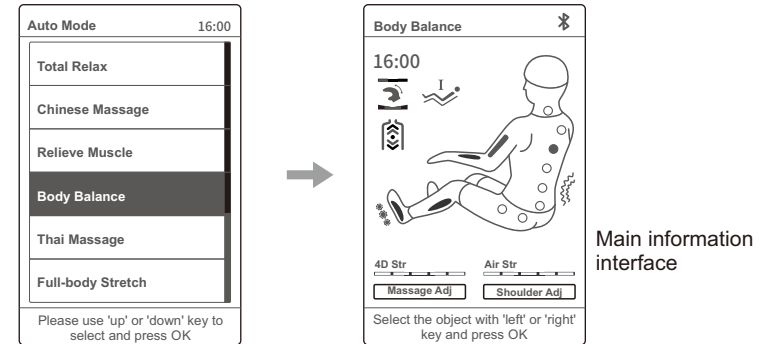

2. Automatic program introduction

Function	Description
Total Relax	With the aid of flexible guide rails, let the body posture angle closer to lying flat; with the effective anti-arch stretching of 3D movement to the back, achieve zero pressure stretching, effectively relieve lumbar muscle pain, and eliminate fatigue, thus to get a better massage experience, relieve the stress on the body and mind. Note: There is background music, which can be turned on or off through the Voice Prompt option in the settings.
Chinese Massage	By means of Traditional Chinese medicine massage technique mainly, apply 3D massage on the back and waist so as to promote the blood circulation of the back and waist, soothe the meridians and relieve the blockage of the back and waist through massage. It is suitable for people with back and waist pain, and lumbar muscle strain. Massage intensity is gentle. Note: There is background music, which can be turned on or off through the Voice Prompt option in the settings.
Relieve Muscle	Apply deep pressure on the neck, back and waist, buttocks, and legs by means of kneading, patting, finger pressing techniques mainly to relieve the fatigue on body, allowing the body to better relax. Note: There is background music, which can be turned on or off through the Voice Prompt option in the settings.
Body Balance	Apply full air massage mainly, with the use of airbags for cross circulation of kneading and pressure, so as to promote blood circulation, alleviate pain in various body parts, and deeply relieve muscle fatigue. (Remarks: full air massage mainly, with frequent air massage action)
Thai Massage	Mainly use calf and backrest electric push rod to clamp legs, hands and shoulders with the aid of air massage, and then apply stretching massage, while the movement holds against the back and waist for 3D medical massage, so that the body is in the Thai stretching state. It is suitable for people under high stress to improve their head-down on chest and humpback. Massage intensity is strong.

Operation Instructions

Full-body Stretch	By means of kneading, patting, finger pressing and medical massage techniques mainly, clamp the legs, hands and shoulders with the aid of air massage, and then apply stretching massage to soothe the meridians, promote blood circulation, relieve blockages in the body.
Neck & Shoulder Care	Massage the neck and shoulders by means of kneading and stretching techniques mainly, and also the upper back by medical massage, and then press the Jianjing acupoint to relieve cervical spondylosis and achieve the effect of relaxing the muscles of the neck and shoulders. Massage intensity is gentle, suitable for people working in office and suffering from cervical fatigue.
Spine Traction	Massage the waist by means of kneading, patting and medical massage mainly, while the movement holds against the back and waist for 3D medical massage, so as to relieve lumbar spine pain; combined with the thermostatic heat configuration around the waist, maintain a comfortable temperature to bring warm massage experience; with gentle and moderate massage intensity and comfortable temperature, bring warm massage experience.
Leg&foot Relieve	Massage the shoulders and waist by means of kneading, patting, kneading and patting mainly, apply air massage on the legs and feet for squeezing massage, allowing more soothing leg and foot massage, suitable for sedentary people with low stress on the legs and feet, not only relieving the cervical spine, lumbar spine pain of sedentary people, but also soothing the legs and feet. Massage intensity is gentle.
Superior Enjoyable	Apply air massage on the whole body, with the foot roller and calf kneading massage. Calf stretching function is canceled, suitable for the elderly and people suffering stress on back. The massage intensity is gentle.
President Cosy	Massage the shoulders, neck, back and waist by means of kneading, patting, kneading and patting mainly, to relieve fatigue, promote blood circulation, and release stress by such deep massage. It is suitable for men, and the massage intensity is moderate.
Keep Fit	Massage the shoulders, neck, waist and hips by means of kneading and finger pressing techniques, through the massage on the whole body, to relax the body and mind, and enjoy the queen-level treatment. It is suitable for women, and the massage intensity is gentle.

Operation Instructions

Office Regimen	Massage the shoulders, neck and waist by means of kneading, patting, kneading and patting techniques mainly, to relieve shoulder and neck pain, improve lumbar muscle soreness and maintain lumbar spine through such deep massage. It is suitable for office white-collar and sedentary people, and the massage intensity is moderate.
Health Recharge	Deeply massage the whole body by means of kneading, patting and finger pressing techniques, to promote blood circulation throughout the body and prevent blood clots. It is suitable for people who live at home for a long time and do not like to go out, and the massage intensity is moderately gentle.
Energy Boost	Massage the waist, shoulders and neck by means of kneading, patting, kneading and patting techniques, to awaken the body's vital energy, stimulate physical energy through such deep massage of the whole body with the massage intensity being heavy, which is suitable for people with strong stress, such as athletes, for stimulating the potential before a race.
Lunch Break	Massage the back and waist by means of kneading and patting techniques, and press the Shenyu acupoint, to improve the quality of lunch break, so that the user is more energetic in afternoon work. It is suitable for office workers, and the massage intensity is gentle.
Back Spa	Deeply massage the whole body by pressing related acupoints by means of kneading, patting, finger pressing and other massage techniques, to let the stimulation fully reach the deep layer of muscle tissue, feel warm locally combined with the function of hot compress, and regulate the Qi and blood in a bid to achieve the effect of warmth and damp expelling. (Note: the whole body massage together with hot compress)
Sweet Dream	Massage the shoulders, neck, back and waist by means of kneading and medical massage techniques, and press the acupoints of Fengchi and Shenyu, to improve the sleep quality and help sleep. It is suitable for people suffering from poor sleep, and the massage intensity is gentle. Note: There is background music, which can be turned on or off through the Voice Prompt option in the settings.

Operation Instructions

VI. Personalization program (please use this function after the chair is turned on)

1. Message modes: as shown in the figure below, open the mode selection menu to select a message mode.

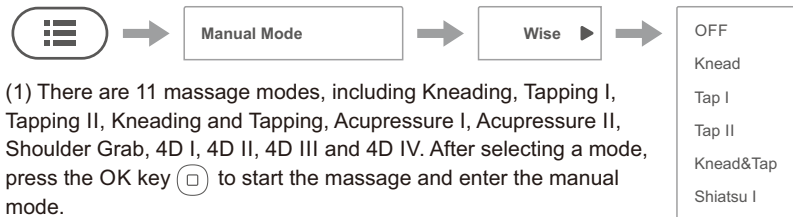

(1) There are 11 message modes, including Kneading, Tapping I, Tapping II, Kneading and Tapping, Acupressure I, Acupressure II, Shoulder Grab, 4D I, 4D II, 4D III and 4D IV. After selecting a mode, press the OK key to start the massage and enter the manual mode.

(2) Message mode display on the information interface.

Function	Message roller adjustment	
OFF	Width.	Adjustable speed in five gears Adjustable width in five gears
Knead	Speed.	
Tap I	Speed and width.	
Tap II	Speed and width.	
Knead&Tap	Speed.	
Shiatsu I	Speed and width.	
Shiatsu II	Speed and width.	
Knock	Speed.	
4D I 4D	Speed.	
4D II 4D	Speed.	
4D III 4D	Speed and width.	
4D IV 4D	Speed and width.	

Operation Instructions

2. Massaged parts: As shown in the figure below, open the message part selection menu to select message parts.

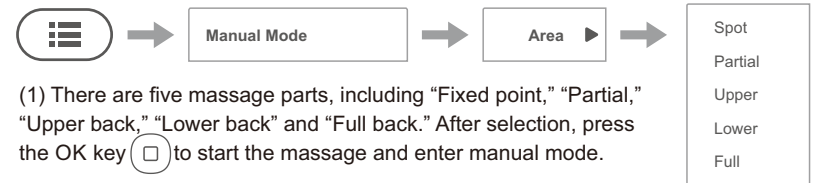

(1) There are five message parts, including “Fixed point,” “Partial,” “Upper back,” “Lower back” and “Full back.” After selection, press the OK key to start the massage and enter manual mode.

(2) Message part display on the information interface.

Function	Description	
Spot	Fixed-point massage at fixed-point position.	You can adjust the massaged area with the Up key and Down key in the information interface.
Partial	Small-scope local massage back and forth.	
Upper	Upper back massage back and forth.	
Lower	Lower back massage back and forth.	
Full	Full back massage back and forth.	

3. Message width: as shown in the figure below, open the width selection menu to select a message width.

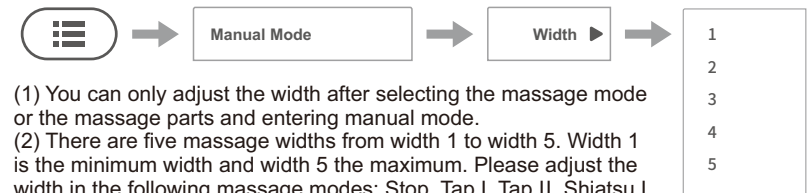

(1) You can only adjust the width after selecting the message mode or the message parts and entering manual mode.

(2) There are five message widths from width 1 to width 5. Width 1 is the minimum width and width 5 the maximum. Please adjust the width in the following message modes: Stop, Tap I, Tap II, Shiatsu I, Shiatsu II, 4D III and 4D IV.

(3) Message part display on the information interface.



Operation Instructions

4. Massage speed: as shown in the figure below, open the speed selection menu to select a massage speed.

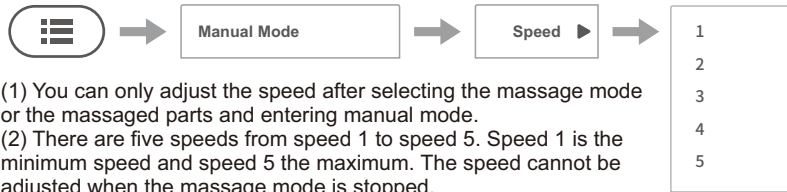

- (1) You can only adjust the speed after selecting the massage mode or the massaged parts and entering manual mode.
- (2) There are five speeds from speed 1 to speed 5. Speed 1 is the minimum speed and speed 5 the maximum. The speed cannot be adjusted when the massage mode is stopped.
- (3) Speed display on the information interface.



VII. Manual program (please use this function after the chair is turned on)

1. Pneumatic massage

(1) Pneumatic mode selection. as shown in the figure below, open the pneumatic message menu to select a pneumatic mode. The pneumatic mode modes include: Upper Body, Lower Body, Whole Body (both the upper body and lower body are massaged pneumatically at the same time), Off (the pneumatic massage function is turned off).

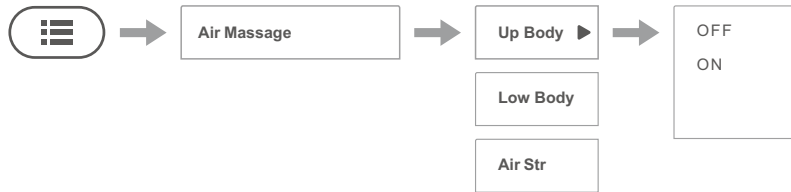

(2) Air pressure adjustment. After the pneumatic massage function is turned on, the air pressure can be adjusted. There are five levels of air pressure. Level 1 is the lowest level and Level 5 the highest.



Operation Instructions

(3) Air pressure display on the information interface.

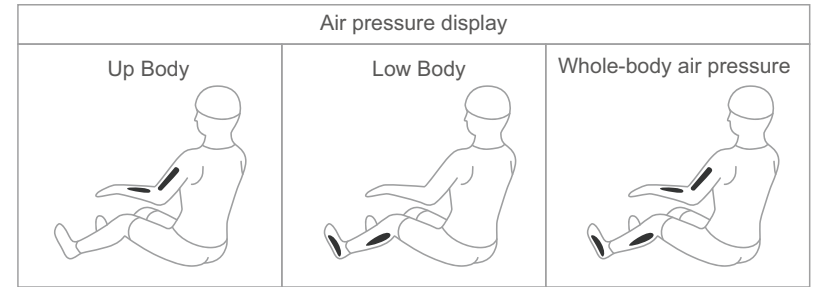

2. Heating function

(1) Heating switch: as shown in the figure below, open the auxiliary function menu to turn backrest heating on or off.

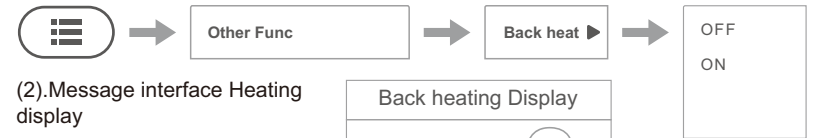

(2).Message interface Heating display

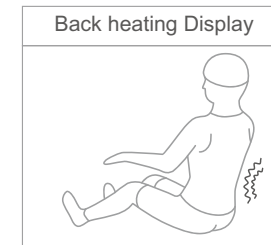

3. Sole roller

(1) Roller switch: as shown in the figure below, open the auxiliary function menu to turn on or off sole rollers.

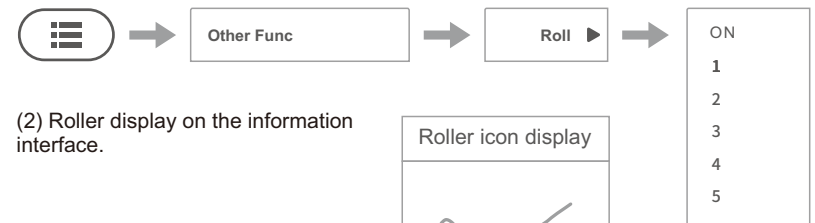

(2) Roller display on the information interface.

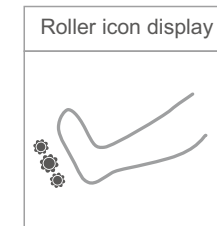

Operation Instructions

VIII. Massage adjustment (please use this function after the chair is turned on)

1. 4D intensity adjustment

As shown in the figure below, open the 4D intensity adjustment menu to adjust the 4D intensity. There are five levels from Level 1 to Level 5. Level 1 represents the minimum intensity and Level 5 the maximum. The stronger the 4D intensity, the higher the massage roller is lifted and the greater the massage intensity. (In the main information interface)

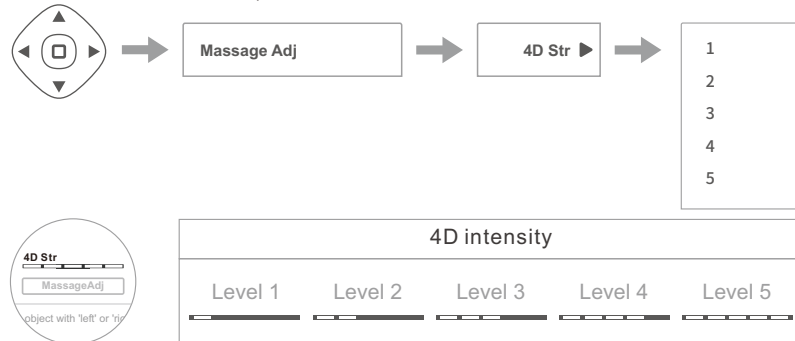

3. Time adjustment

As shown in the figure below, open the time adjustment menu to increase or decrease the massage time and the adjustment range is 0–40 minutes. When the massage time is counted down to 0, the massage chair will be turned off automatically, the massage rollers will be reset and the posture of the massage chair will remain unchanged. (In the main information interface)

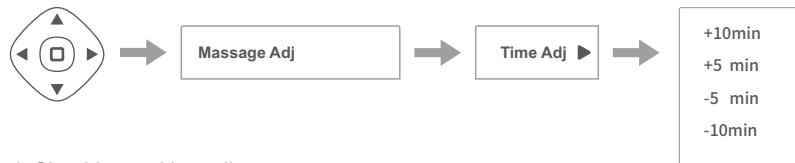

4. Shoulder position adjustment

As shown in the figure below, open the shoulder position menu to finely adjust the shoulder positions upwards or downwards. When the mechanical arms press your shoulders, if you feel the positions are inaccurate, you can adjust the shoulder positions. (In the main information interface)



Operation Instructions

IX. Angle adjustment (please use this function after the chair is turned on)

1. Zero-gravity

There are three levels corresponding to the three set angles of the massage chair. You can press the Zero-gravity key (🪑) to switch repeatedly between the three zero-gravity levels or turn off the zero-gravity.

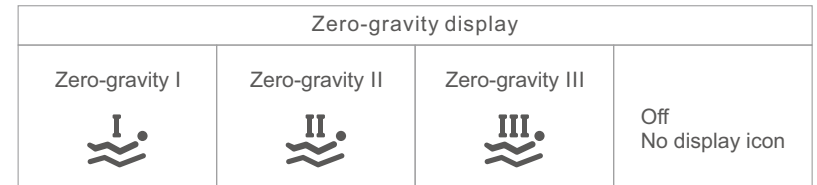

2. Whole body angle

Press and hold the sitting position lowering key on the remote control (🪑) to start adjusting the angle of the massage chair downwards, where the backrest mechanism is lowered and the leg mechanism is raised, the adjustment will stop when the key is released.

Press and hold the sitting position raising key on the remote control (🪑) to start adjusting the angle of the massage chair upwards, where the backrest mechanism is raised and the leg mechanism lowered and release the key to stop the adjustment. When the adjustment reaches the limit position, the adjustment will stop and beeps will be emitted.

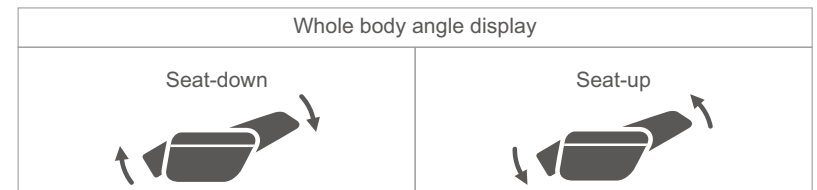

3. Leg mechanism angle

Press and hold the leg mechanism lowering key on the remote control (🪑) to start adjusting the angle of the leg mechanism downwards, release the key to stop the adjustment.

Press and hold the leg mechanism raising key on the remote control (🪑) to start adjusting the angle of the leg mechanism upwards, release the key to stop the adjustment.

When the adjustment reaches the limit position, the adjustment will stop and beeps will be emitted.

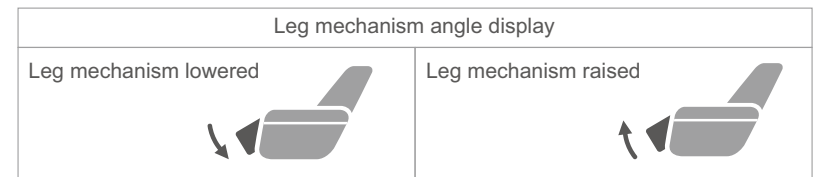

Operation Instructions

4. Leg mechanism length

Press and hold the leg mechanism extending key  on the remote control to extend the leg mechanism, release the key to stop the adjustment.

Press and hold the leg mechanism contracting key  on the remote control to contract the leg mechanism and release the key to stop the adjustment.

When the adjustment reaches the limit position, the adjustment will stop and beeps will be emitted.



X. Health check (please use this function after the chair is turned on)

1. Start a health check

As shown in the figure below, select Health Check for a health check. After entering the health check state, please keep your body relaxed. Gently place your index or middle finger on the sensor and wait until the check is completed.

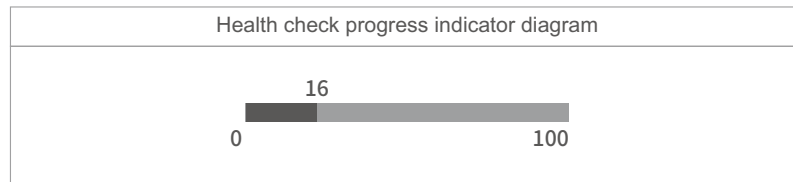

2. Recommended program

After the normal check is completed, the heart rate, blood oxygen and fatigue level will be displayed. Blood oxygen refers to the blood oxygen concentration, of which the normal range is 95%–99%. There are four fatigue levels: “Good state,” “Mild fatigue,” “Moderate fatigue” and “Severe fatigue.” According to your fatigue level, an automatic program will be recommended for you automatically. You can select “Yes” to start the recommended program or select “No” to resume the massage state before the health check.



3. No valid data is detected.

If no valid data is detected, you will be prompted whether or not to take the check again. You can select “Yes” to restart the health check, or select “No” to exit the check and resume the massage state before the health check.





Operation Instructions

4. Exit health detection.

During health detection, press the OK key to exit the detection and return to the massage state before the health detection.

XI. My Favorites (please use this function after the chair is turned on)

As shown in the figure below, open the My Favorites menu interface. Select the “+” option and press the OK key  to add the currently running massage program to My Favorites. Next time, when you want to run this massage program, in the My Favorites interface you can just select the program that has been added to My Favorites and press the OK key . The same massage program cannot be added repeatedly and only up to 3 massage programs can be saved. You can select a favorite program and press and hold the OK key  to delete the favorite.

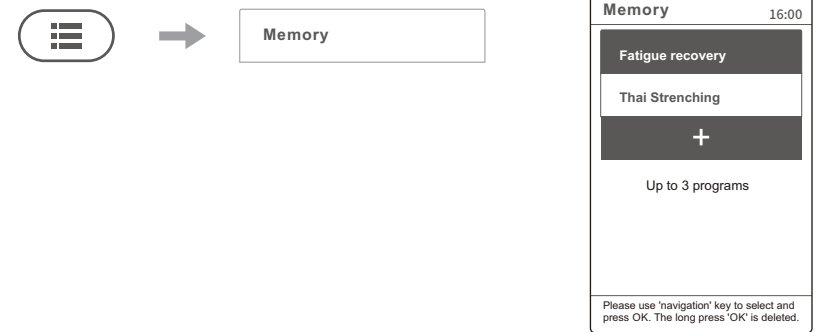

XII. System Settings (please use this function after the chair is turned on)

1. Bluetooth: as shown in the figure below, open the Bluetooth Settings menu to enable or disable the Bluetooth speaker function. After the Bluetooth speaker function is enabled, you can play music by connecting to a smart device (mobile phone, tablet, etc.). The connection method is as follows:

- (1) Turn on the Bluetooth function of the smart device, search for the Bluetooth name with the words "IMCM-XXXXXX" and connect.
- (2) Open the music player on the smart device to play music.



2. Voice assistant: as shown in the figure below, open the voice assistant setting menu to enable or disable the voice assistant function or press and hold the voice key  on the right armrest to enable or disable the voice assistant function. After turning on the voice assistant, you can use the voice assistant function to control the massage chair. The operating method is as follows:

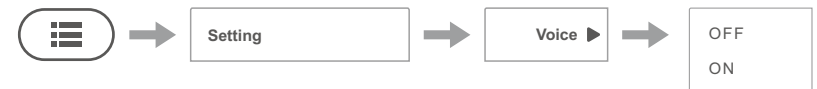

Operation Instructions

(1) You can say "Hi Alice" or "Hey Alice" near the speaker or press the Voice key  on the right armrest to wake up the voice assistant. When replying "I am here", the voice assistant has been awakened.

(2) After waking up the voice assistant, please say your command within 6 seconds to control functions of the massage chair. After the voice assistant responds to your command, you can continue to say another command. Be sure to keep an interval of no more than 6 seconds between every two adjacent commands. Otherwise, you need to wake up the voice assistant again. The detailed voice command table is as follows:

Voice Control Entry		
Entry: "Hi Alice" or "Hey Alice". Answer: I am here.		
No.	Voice control entry	Answer entry
1	Massage on	Answer: Ok, Massage on
2	Massage close	Answer: Ok, Massage close
3	Total Relax	Answer: Ok, Total Relax
4	Energy Boost	Answer: Ok, Energy Boost
5	Sweet Dream	Answer: Ok, Sweet Dream
6	Neck & Shoulder Care	Answer: Ok, Neck & Shoulder Care
7	Lunch Break	Answer: Ok, Lunch Break
8	Thai Massage	Answer: Ok, Thai Massage
9	Open the air pressure	Answer: Ok, Open the air pressure
10	Close the air pressure	Answer: Ok, Close the air pressure
11	Up the seat position	Answer: Ok, Up the seat position
12	Down the seat position	Answer: Ok, Down the seat position
13	Change the other mode	Answer: Ok, Change the other mode
14	Go little down	Answer: Ok, Go little down
15	Go little up	Answer: Ok, Go little up

Note: commands 14 and 15 can only be used after command 13.

Operation Instructions

4. Voice Prompt: as shown in the figure below, enter the voice prompt setting menu to enable or disable voice prompt and background music.

- (1) Voice Prompt: During the process of using the massage chair, the user will be prompted how to use the massage chair correctly, helping new users to get familiar with the massage function more quickly.
 (2) Background music: Four automatic programs of "Total Relax", "Chinese Massage", "Relieve Muscle" and "Sweet Dream" play background music.

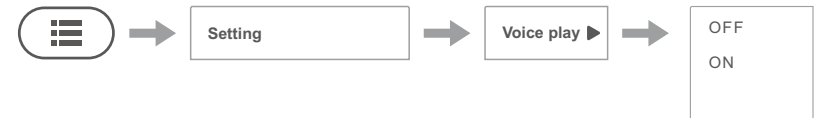

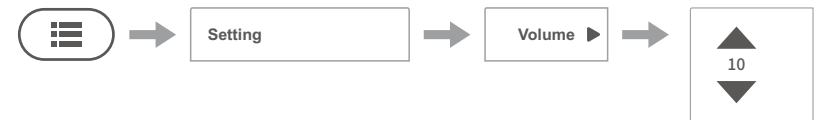

3. Volume: as shown in the figure below, you can open the volume setting menu to set the system volume, and use the Up key \blacktriangle and the Down key \blacktriangledown to adjust the volume. There are 15 volume levels available.

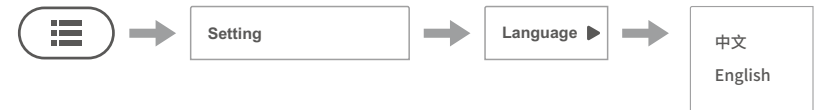

4. Language: as shown in the figure below, you can open the language setting menu to set the system language. There are Chinese Simplified and English options.



XIII. End the massage

1. During the massage, you can press the On/Off key on the remote control  or the On/Off key on the right armrest  to turn off the chair. Immediately turn off all massage functions, re-set the backrest unit and the leg unit or when the massage timing time arrives, all massage functions will be automatically turned off, with the backrest unit and the leg unit not re-set.

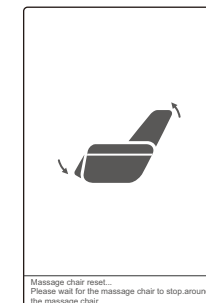

Operation Instructions

Cut off the whole machine power supply, as shown in the figure (Schematic diagram of power switch position of the whole machine).

Turn off the power switch ("0" position)

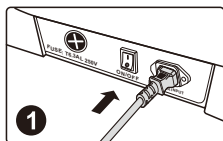

Schematic diagram of pulling out the power plug

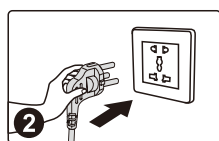

Remove the product connection power cord

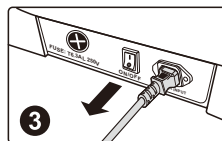

Cleaning and Maintenance

Cleaning synthetic leather and plastic parts

Wipe the leather with a soft, dry cloth.

■ Do not use chemicals such as thinner, gasoline, alcohol, etc. to clean the unit.

■ When using commercially available leather care products (rags), please follow the instructions for use.

■ If synthetic leather is particularly dirty, wipe it in the following way.

- ① Immerse a soft cloth in water or hot water containing 3% to 5% neutral detergent, then wring it out thoroughly.
- ② Use the above soft cloth to wipe the leather surface.
- ③ Wipe off the cleaning solution with a cloth soaked in clean water and thoroughly wrung out.
- ④ Wipe with a wrung soft cloth.
- ⑤ Let it air dry naturally.

■ When it is difficult to remove stains, please immerse commercially available melamine foam in neutral detergent, and then wipe the machine with it.

■ Do not use a hair dryer to dry the surface.

■ Be careful when wiping the machine with denim and colored fabrics, as the color of the fabric will stain the surface of the synthetic leather.

■ Do not keep these parts in contact with plastic for a long time, as this will cause discoloration.

■ Synthetic leather may be discolored, so when using hair dye, please cover the touched part with a towel.



Troubleshooting

Fault	When the calf mechanism or the backrest reaches a certain position, press the corresponding adjustment button and it will no longer change, and a continuous "beep, beep" sound will be emitted.
Solution	Due to product structure design and ergonomic requirements, this product has a limited protection design for the limit state of attitude adjustment. At the same time, a reminder sound will sound when the limit is reached.
Fault	The function does not work or some functions do not work after the machine is turned on.
Solution	After the machine is turned on by pressing the switch key, it is necessary to manually select an automatic massage program or other working state. If it is not operated, the machine will automatically shut down after 20 minutes. If the manual operation mode is selected, the functions that are not selected may be disabled, and the working mode needs to be manually set in the manual mode.
Fault	The machine makes a leather rubbing sound when adjusting its posture.
Solution	This product adopts high-grade anti-corrosion leather that meets environmental protection requirements. Due to the inherent characteristics of leather materials, there will be a normal slight noise when rubbing at the relative movement, which is a normal phenomenon. Note: If you hear fabric or leather tearing sound when the machine is running, please stop using it immediately and seek professional maintenance.
Fault	The massage wheel did not reach the shoulders or neck.
Solution	If the head does not touch the head cushion or the back does not touch the backrest, the shoulder position may be lower than the actual position during the body shape detection process. Sit in the deepest position of the seat, rest your head on the headrest, and start over from the beginning.
Fault	The unit is damaged. The power cord or power plug is abnormally hot.
Solution	To prevent accidents, be sure to contact an authorized service center.

Please feel free to contact the designated service personnel for any questions or doubts about this product.

Product specifications

Model: A550
 Configure: 2
 Name: Massage Chair
 Rated voltage: 220-240V~ 50Hz/60Hz
 Rated power: 120W
 Rated time: 20min
 Safety structure: Class 1

Max User Height: 205 cm
 Max User Weight: 150kg
 Net Weight: 106 kg
 Gross Weight: 120 kg
 Package Measurement: 188 * 76 * 82.5 cm

Material description: PVC, PA, steel parts, electric and electron component

MATERIAL	PU	LEATHER	CLOTH	WOOD